

# **V**ARME

## Floor Heating Systems

### **Instructions for installation of Undertile Heating Undertile Cable Kit & Undertile Cable Mat**

#### ***Contents***

Page 2	Product Overview
Page 3	Installation Notes
Page 3	Electrical Provision
Page 4	Preparation
Page 5	Heating Cable Installation
Page 9	Heating Mat Installation
Centre Pages	Guarantee Certificate
Page 14	Troubleshooting & FAQ's

For help and advice regarding this product, please contact the Floor Heating Helpline: 0115 963 2342



## Product Overview

### Overview:

This instruction manual covers the electrical provision and installation of both the Undertile heating cable kit and cable mat. Before you begin installing please read through these instructions carefully and check that you have all the components required.

These systems are designed for installation below tiles, stone or marble flooring. They may also be installed below vinyl, laminate and thin carpets but in these cases must be first covered with a flexible floor levelling compound.

### Important Notes:

- DO NOT cut or cross the heating cable**
- DO NOT fit the system without testing the heating element(s)**
- DO NOT supply power to the heating element whilst it is coiled or partially coiled**

### Contents of heating kit:

- 3mm twin-core Heating Element (mat or loose cable)
- Acrylic floor primer 500ml
- Disposable roller for application of primer
- High adhesion fixing tape (loose cable systems only)
- Digital thermostat and separate floor sensor
- Flexible Conduit
- Guarantee Certificate

### Additional Items that will aid installation

- Tape Measure
- Electrical Test Equipment *\*(see note below)*
- Marker Pen or Pencil (Loose Cable system)
- Self-Adhesive Cloth tape (Cable mat system)
- Knee Pads
- Retractable Knife
- Scissors

### Live & Neutral

Can be connected to the load terminals of the thermostat either way around

### Earth Braid

Must be connected to earth

### Black Cold Cable

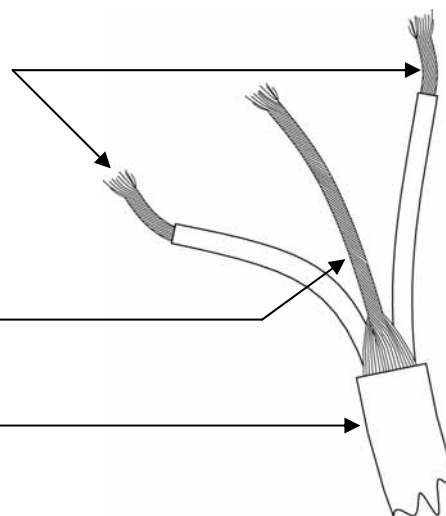

*\* Note: A multi-meter will suffice for preliminary testing of the cable prior to laying of the floor finish. Final testing for completion of the guarantee must be performed by your electrician with calibrated test equipment.*



## Installation Notes

- The system requires a mains voltage 230V AC and must be connected in compliance with building regulations Part 'P' and current wiring regulations.
- The 'cold' cable attached to each heating element is double insulated and the first outer sheath (coloured black) carries an earth screen (the silver coloured braid). The heating element also contains a built in return meaning that the cable only has to be connected to the thermostat from one end. **Inside the outer sheath there are 2 wires, these are the live and neutral, normally not coloured (occasionally coloured) these can be connected either way around.**
- For larger areas, if two or more heating elements are supplied, these can usually be connected together at the thermostat or by using a small blank fronted connection box.
- The system is suitable for installing on any sub-floor<sup>1</sup> which is sound and suitable for tiling. In the main this will be concrete, plywood or cement faced tile-backer boards. Some water resistant composite boards may also be suitable, but it is not recommended to tile directly onto hardboard, MDF or standard grade chipboard as these substances absorb moisture and subsequent swelling could cause tiles to crack or dislodge. Note - if installing on a newly finished concrete screed the required minimum drying out or 'curing' period should be followed before installing (this is typically 1day per millimetre in good conditions).
  1. Bitumen or asphalt coated floors need to be covered with either a tile backer board or latex levelling compound. If the bitumen is present only as a thin residue then you may lay the heating system directly on top
- The electrical and electromagnetic fields generated are negligible and well within all recommended European and International guidelines.
- The heater cable MUST NOT be cut or cross at any point.

## Electrical Provision

### Important Notes:

Make the electrical provision as per the diagram Fig.1. The circuit must incorporate a 30mA RCD protection

For installations below 13Amp, A fused spur or combined spur/RCD is recommended.

For installations over 13Amp a suitable isolated supply should be provided incorporating 30mA RCD protection.

The thermostat rating varies depending upon which model is being installed. Refer to the thermostat instructions to determine the maximum current that the thermostat can switch. It will be either 15 or 16 Amps (most domestic installations are within this figure). If the system supplied is over the maximum rating of the thermostat it will be subject to a more comprehensive electrical installation. (Your electrician will be able to advise you on this).

Note: all electrical connections should be made in compliance with building regulation Part 'P' and current wiring regulations.

Note if installing in a bathroom or other 'wet' room the thermostat must be located OUTSIDE of the room, on the opposite side of the wall, for example in a bedroom or hallway/landing.

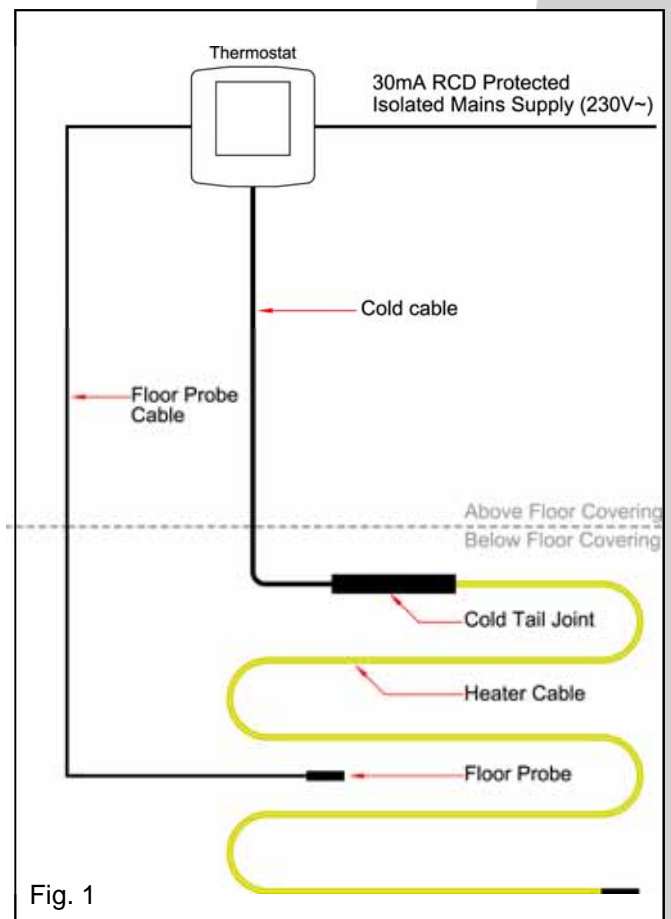

Fig. 1



## Preparation

Ensure that the sub-floor is solid, suitable for tiling and free from dust and debris. Wood flooring with more than 40cms between the joists should ideally be reinforced to prevent flexing and the possibility of tiles dislodging. Wood flooring can be reinforced using 18mm WBP plywood, Marine plywood or insulated tile-backer boards.

### Insulation

The insulation levels of a floor will affect both the performance and running costs of an underfloor heating system and although not essential in many cases, it is recommended wherever possible. For example it would not be considered necessary to insulate small areas where the requirement is simply to 'take the chill off the floor', however in cases where the heating is being installed over large areas, particularly as the primary heating source in a ground floor room or conservatory, insulation boards will greatly reduce warm-up times and running costs. Suitable insulation boards are available from your underfloor heating retailer/supplier.

### Step 1

First prepare the sub-floor ensuring that it is clean and free from grease, dirt or debris. Fig.2

Note - if installing on a bitumen or asphalt base, this must either be removed or covered. For further information, refer to the FAQ's on the back page of this manual or contact the floor heating helpline.

The most suitable sub-floors are: concrete, tile-backer boards, existing tiles, water-resistant timber e.g. WBP Ply.

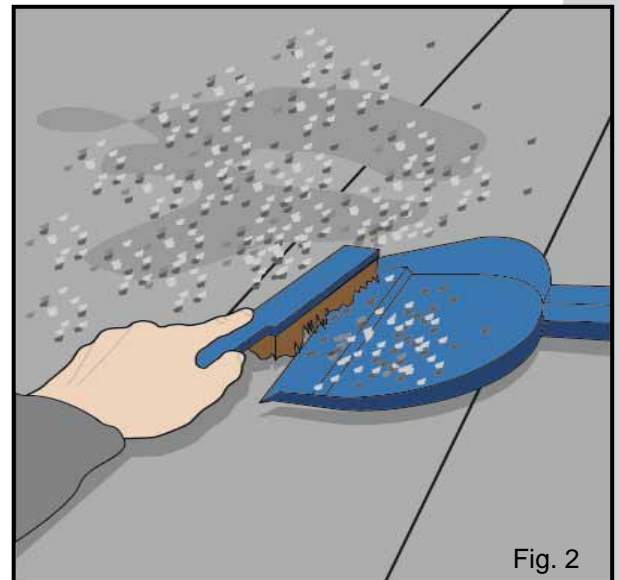

Fig. 2

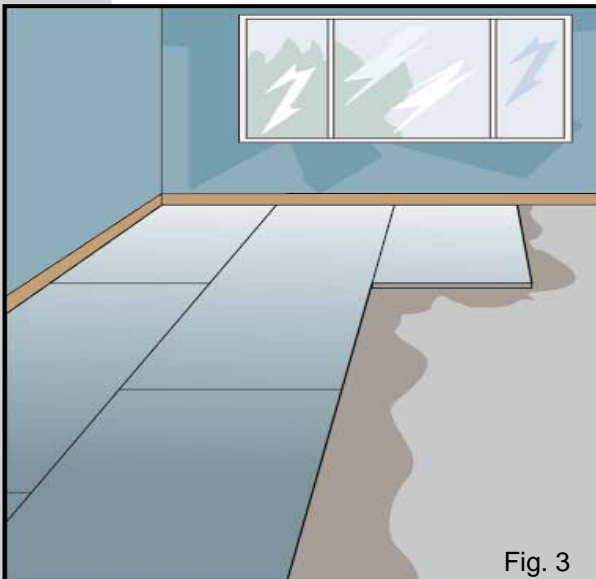

Fig. 3

### Step 2

If fixing tile-backer boards, do so in accordance with the separate instructions provided, using tile adhesive on a concrete sub-floor Fig 3, or galvanised screws with washers/fixings on timber sub-floors.



Fig. 4

### Step 3

Prime the floor or the tile backer boards using the Acrylic primer contained in the kit. If installing over a large area or on an absorbent surface the primer may need to be diluted in accordance with the primer instructions. Once primed leave to dry (typically 1-3 hours) and avoid foot traffic over this area. The purpose of priming is to promote greater adhesion and reduce the amount of moisture absorbed into the sub-floor Fig. 4. Before proceeding to step 4 see note below

**Cable Kit** Installation instructions go to step 4 on page 5  
**Cable Mat** Installation instructions go to step 4 on page 9



## Cable Kit Installation

### Important notes

The system is intended for heating tiles, stone or marble flooring, it may also be installed below vinyl, laminate and thin carpets but in these cases must be first covered with a suitable levelling compound. The optimum recommended output is approx 150W/m<sup>2</sup> achieved by spacing the cable at around 6.5cms between the loops. Exact cable spacing should be calculated before installation (see step 5).

*Note: A multi-meter will suffice for preliminary testing of the cable prior to laying of the floor finish. Final testing for completion of the guarantee must be performed by your electrician using calibrated test equipment.*

### Step 4

Calculate the cable spacing. This is a very important step and **MUST** be done correctly to ensure all the cable is used up and avoid extra work later.

First measure the area to be heated in sqm (do not include the area taken up by fixed objects such as baths/showers and kitchen units), then divide this area by the length of the cable shown on the drum. The cable is 10 watts per linear metre so, for example, a 750 watt kit contains 75 metres of heating cable.

The spacing is calculated by dividing the total sqm of the area to be heated by the cable length in metres. Example Fig 5.

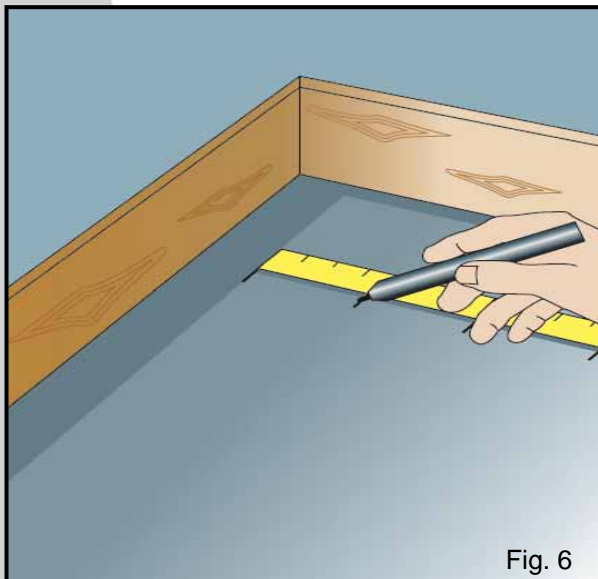
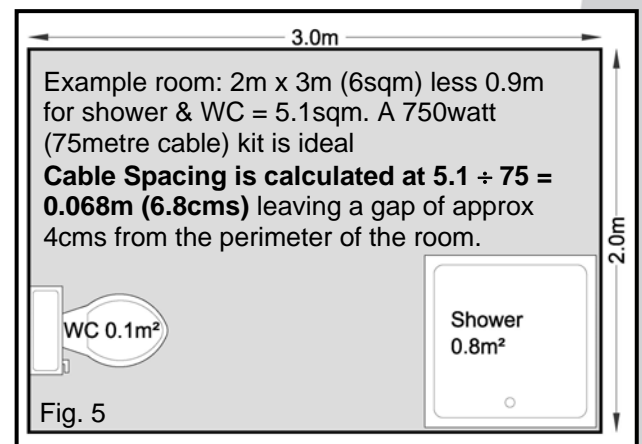

Fig. 6

### Step 5

Once the spacing has been determined, leaving a perimeter of 3-5cms around the edge of the room, mark out on the floor at the calculated intervals. This will usually be between 6 and 8cms Fig 6.

If your calculated spacing is less than 5cms **STOP** and do not install – the kit size is too large for the room.

A spacing of 10cms will in many cases only take the chill off the floor. Used as a heating source in most domestic situations the spacing should be between 6-8cms (this is always dependent on insulation levels and type of floor construction).

### Step 6

Test the resistance of the cable prior to installing Fig.7 and ensure that the reading is as per manufactures design reading. This can be found on the adhesive label on the reel or printed on the PVC sheath ( $\pm 10\%$ ). Make a note of the reading. Test the insulation of the cable by checking that there is no electrical continuity between each of the conductors and the earth braid. If you find there is continuity contact your underfloor heating supplier or the floor heating helpline printed on the back of these instructions.

**Do not tile over the cable without testing it.**

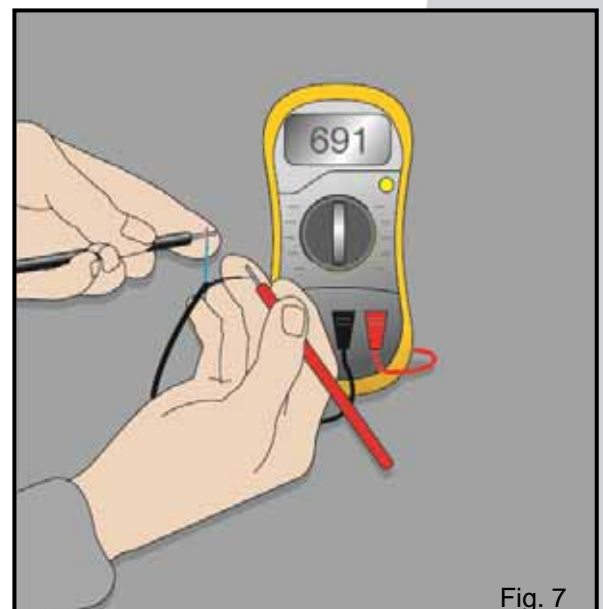

Fig. 7



## Cable Kit Installation Continued.....

### Step 7

Once marked out, position one roll of tape in each corner of the room Fig 8. Begin to loop out the cable as shown. At this stage only use a single line of tape at each edge in case you have to adjust the spacing slightly later. Fig 9.

You must ensure that the cable is only installed in the 'free floor area' and is **NOT** routed below any fixed objects or drains. Note – the joint between the black 'cold' cable and the 'heater' cable **MUST** be located under the final floor covering. Eg. under the tiles.

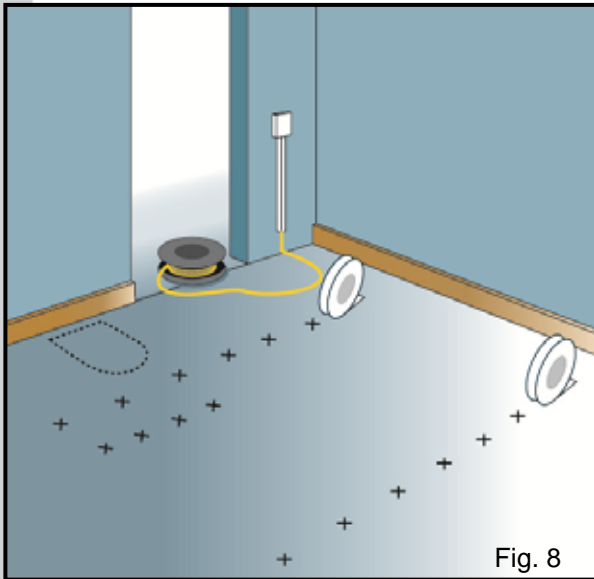

Fig. 8



Fig. 9



Fig. 10

### Step 8

Adjust the spacing if necessary to ensure all the cable is used up and the floor has an even covering.

Cables should be spaced no closer than 50mm (5cm). Tape over the cable at regular intervals ensuring that it is well secured to the floor Fig 10.

### Step 9

Test the resistance of the floor probe. Refer to the label on the floor probe wrapper for desired resistance readings. Make a note of the reading on the guarantee certificate.

The floor sensor should be installed within a flexible conduit. Fig 11. The conduit should be positioned so that the tip of the sensor is between two runs of cable, in a location that will not be covered by rugs or low profile furniture.

The sensor wire should not cross the heating cable at any point. The sensor wire can be shortened or if necessary, lengthened with 2 core flex cable minimum 0.75mm<sup>2</sup> to a maximum length of 50m. If you need to cut the sensor wire you must only cut the cable end. **DO NOT** cut the end which contains the plastic coated floor sensor.



### Cable Kit Installation Continued.....

Each System is supplied with a length of 10mm flexible conduit (only one tube is required for each thermostat), this is for the floor sensor/probe, so that in the unlikely event that it fails, it can be easily removed and replaced.

Fig. 11

Installation of the conduit should be done carefully to make the bends as smooth and shallow as possible.

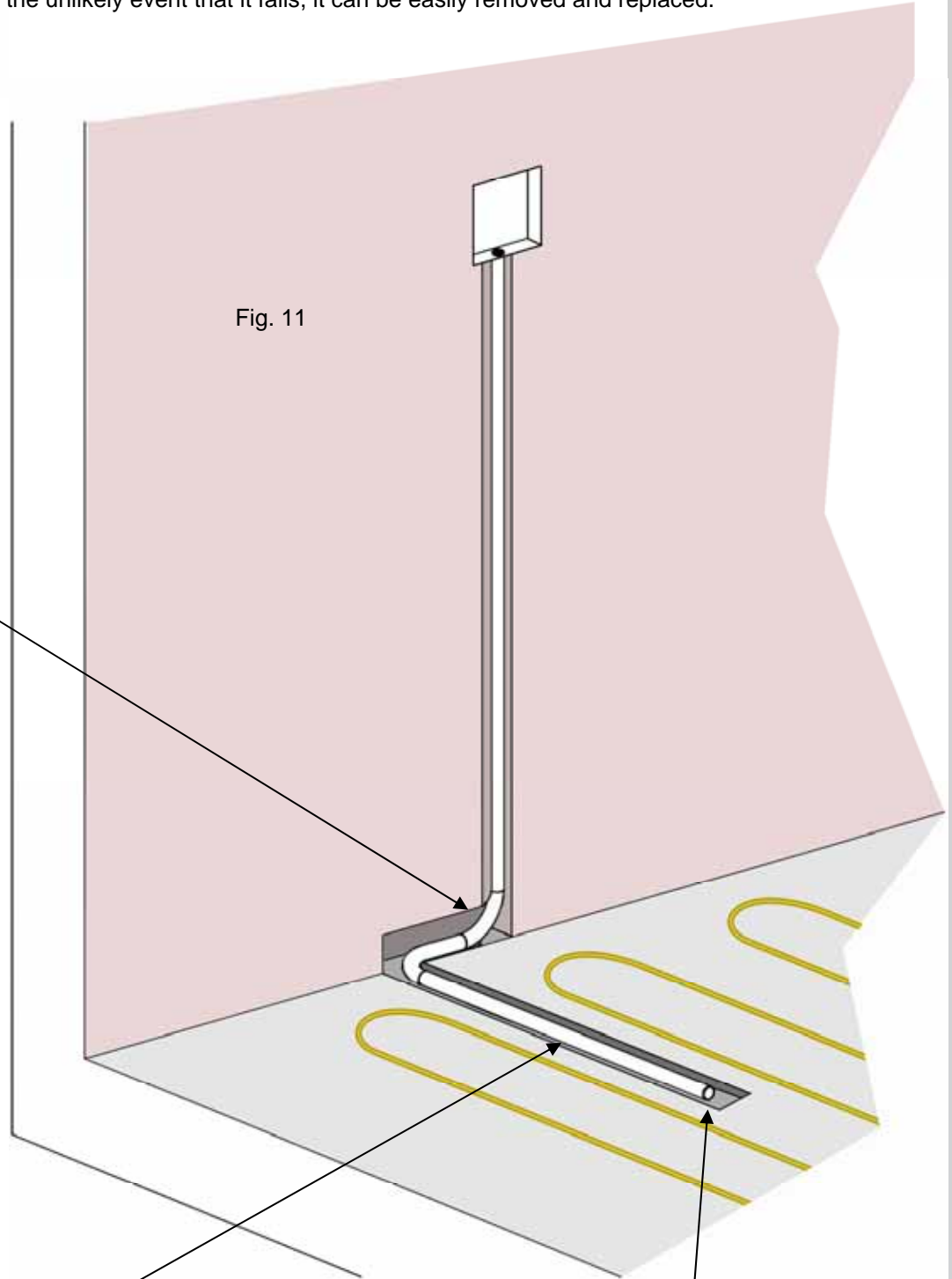

In some situations a small channel may have to be made in the floor to accommodate the tubing. If so, cut a channel from the thermostat position approximately 20cm across the floor.

It is important that the channel is positioned so that it lays between two heating wires and not across them.

The end of the conduit that is in the floor should be sealed with tape to prevent adhesive entering the tube.



## Cable Kit Installation Continued.....

### Step 10

Test the cable resistance and the insulation along with the floor probe immediately prior to tiling to ensure that neither has been damaged. Compare readings with those recorded earlier.

*Note: This test can be performed at any stage of tiling for peace of mind. A cable break monitor device can also be used to alert you if the cable has been damaged. Such devices are available from your underfloor heating supplier.*

**UNDER NO CIRCUMSTANCES** should power be supplied to the cable when it is still on the drum or partly coiled up.

### Step 11

If possible cover the cables with a thin layer of flexible levelling screed (3-4mm) this will help protect the cables when tiling Fig 12. Suitable products will usually be available from your tile supplier. If you have any difficulties refer to FAQ's on the back page of this manual or contact the floor heating helpline. If you do not wish to use a levelling screed, you may tile directly over the cables in a single operation, however extra care must be taken not to damage or dislodge the cables.

Tile the floor using a flexible tile adhesive and grout as per industry standards and the manufacturers instructions. If you are using a suitable vinyl or thin carpet as the final flooring we recommend a minimum of a 6mm layer of levelling screed over the cables to ensure even heat distribution.

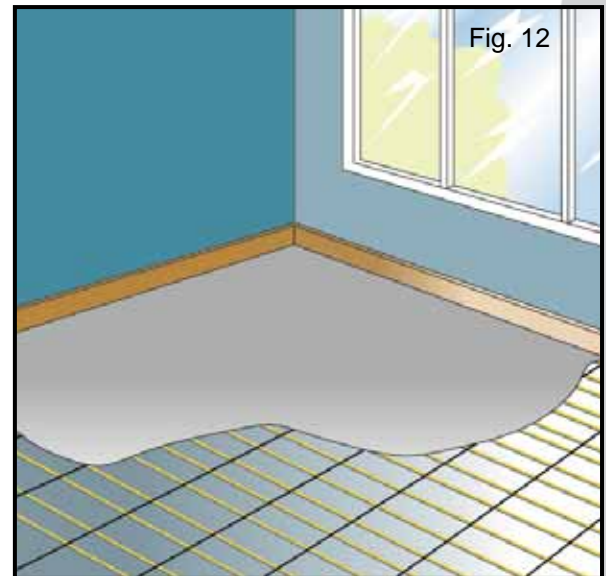

### Step 12

After the floor covering has been laid, test the Cable and Floor Probe one last time to ensure that neither have been damaged. Record final readings and complete the Guarantee Certificate as per the instructions on the certificate. If this is not done the Guarantee is invalid. Retain the certificate for your records.

### Step 13

The connections to the thermostat can now be made. (see separate thermostat instructions). Final connections to the thermostat must be performed by a competent person. Refer to Electrical Industry standards and Building Regulation Part 'P'.

**NOTE:** The heating may be slow to react at first especially if installed on a new screed floor or in a new building. Start by setting the floor temperature at around 20-22°C and build up by 1°C per day until your desired temperature is reached.

#### DO'S and DON'TS

- |              |   |
|--------------|---|
| <b>DO</b>    | Read through these instructions carefully before beginning work   |
| <b>DO</b>    | Use flexible adhesives and grouts   |
| <b>DO</b>    | Test the cable BEFORE tiling. See steps 6, 9, 10 and 12   |
| <b>DO</b>    | Be careful not to damage or dislodge the cable during tiling  |
| <b>DO</b>    | Ensure the cable is spaced no closer than 50mm between loops  |
| <b>DO</b>    | Try to protect the cable with cardboard or carpet during tiling   |
| <b>DO</b>    | Wait at least 7 days before turning on the system   |
| <b>DO</b>    | Read the separate installation and operating instructions for the thermostat                                  |
| <b>DO</b>    | Ensure that the joint between the black 'cold' cable and 'heater' cable is beneath the tiles.                 |
| <b>DO</b>    | Take a photograph of the floor heating cables or draw a plan before they are tiled over for future reference. |
| <b>DON'T</b> | Attempt to cut the heater cable at any point  |
| <b>DON'T</b> | Allow the wires to cross or touch   |
| <b>DON'T</b> | Allow excessive foot traffic over the wire before tiling  |
| <b>DON'T</b> | Cut tiles directly over the cable   |
| <b>DON'T</b> | Place tools or stacks of tiles on top of the cable  |
| <b>DON'T</b> | Turn the system on until the floor covering has been laid and allowed time to set.                            |





## Cable Mat Installation

### Important notes

The system is intended for heating tiles, stone or marble flooring, it may also be installed below vinyl, laminate and thin carpets but in these cases must be first covered with a suitable latex based levelling compound.

*Note: A multi-meter will suffice for preliminary testing of the cable prior to laying of the floor finish. Final testing for completion of the guarantee must be performed by your electrician with calibrated test equipment.*

### Step 4

**Read through steps 4-12 of the cable mat installation instructions fully, then plan the mat layout.**

This is a very important step and **MUST** be done correctly to ensure all the mat is used up. Once the mat has been unrolled it cannot be returned.

It is advisable to produce a drawing showing the proposed mat layout. Start by measuring the floor area to be heated (do not include the area taken up by fixed objects such as baths/showers and kitchen units).

The following *examples* will help you to plan your layout. Please note these are only to be used as a general guide. There are hints and tips in each of the examples so it may be beneficial to read all of them if you have not installed cable matting before.

**If the heated area is smaller than the chosen mat size STOP and return or exchange for the correct size.**

#### Example 1: Fig.13

Typical mat installation in a rectangular shaped room.  
Example shown is a 5m<sup>2</sup> cable mat  
(10m total length of mat)  
divided into 5 runs each of 2m long with a 50mm gap between each run of matting to maintain minimum cable spacing

Thermostat →  
Sensor Tip →  
Cold Cable Joint →

Fig. 13

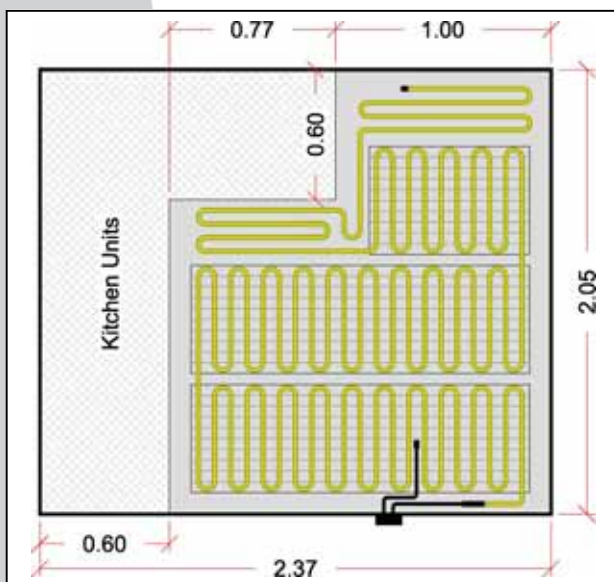
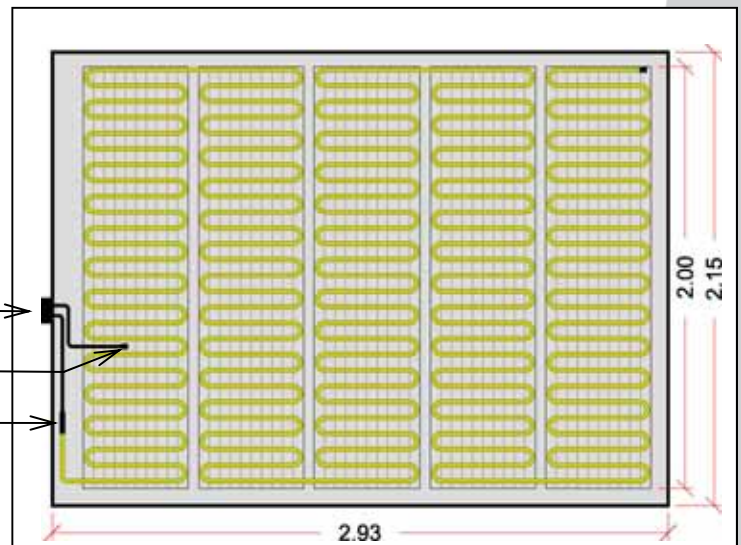

Fig. 14

#### Example 2: Fig.14

A sample mat installation in a kitchen.

Example shown is a 2.5m<sup>2</sup> cable mat  
(5m total length of mat)

3 full width runs each laid to maintain a 50mm gap between cable loops. Two of the mat runs are approximately 2.2m long and the third run is 0.9m. The remainder of the cable is removed from the mesh matting, laid loose and fixed in place with self adhesive cloth tape (duct tape). When run loose, the cable should be spaced, similarly to when it is attached to the matting. Cables should be spaced no closer than 50mm.

### Cable Mat Installation Continued.....

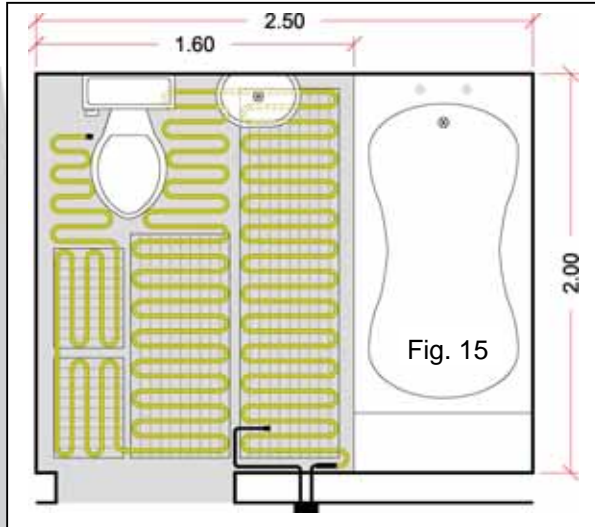

#### Example 3: Fig. 15

Typical bathroom installation:

Example shown is a 2.5m<sup>2</sup> cable mat

(5m total length of mat)

2 full width runs in front of the bath, each laid to maintain a 50mm gap between cable loops. Areas where a full width of mat cannot be laid, the cable is removed from the mesh matting, laid loose and fixed in place with self adhesive cloth tape (duct tape). When run loose, the cable should be spaced, similarly to when it is attached to the matting. Cables should be spaced no closer than 50mm. Matting can also be laid 90° to main runs of matting.

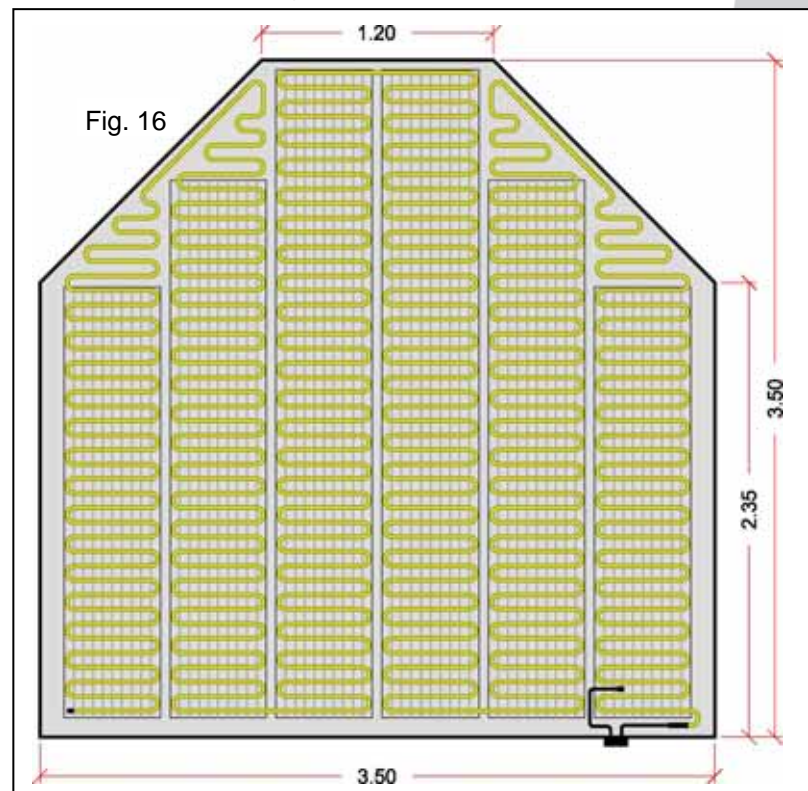

#### Example 4: Fig. 16

Victorian Style Conservatory installation:

Example shown is a 9m<sup>2</sup> cable mat

(18m total length of mat)

6 full width runs of mat, each laid to maintain a 50mm gap between cable loops. The angled sides of the room create irregular areas which can be filled by removing the cable from the mesh matting, laid loose and fixed in place with self adhesive cloth tape (duct tape). When run loose, the cable should be spaced, similarly to when it is attached to the matting. Cables should be spaced no closer than 50mm.

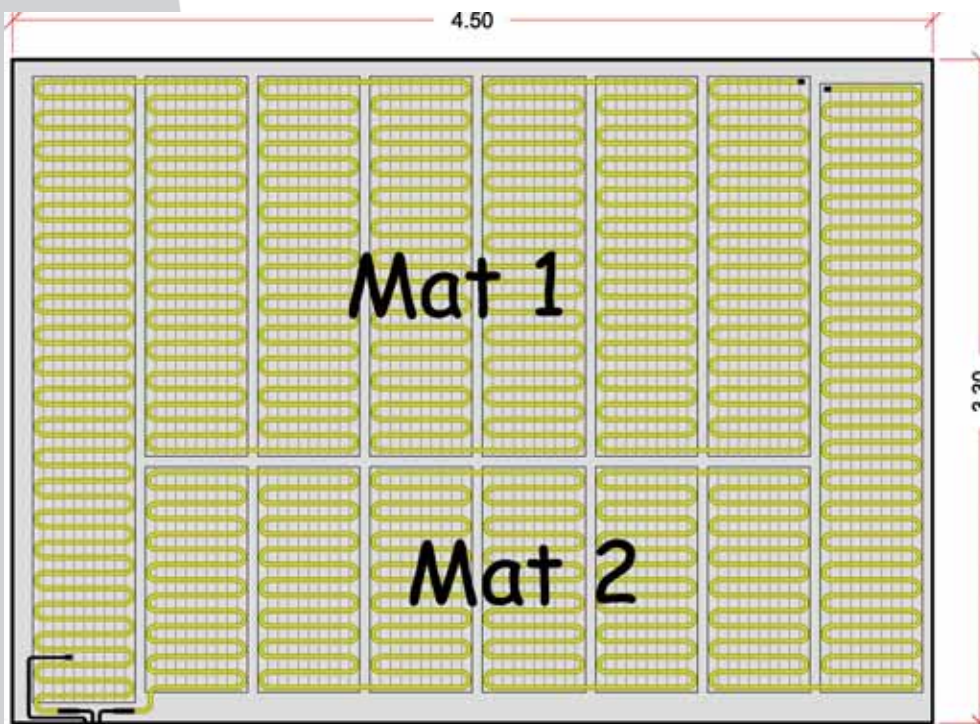

#### Example 5: Fig. 17

Multiple mat installation:

Example shown is a 13m<sup>2</sup> cable mat

(14m + 12m total lengths of mat)

8 full width runs of mat, each laid to maintain a 50mm gap between cable loops. As the thermostat is located at one end of the room, the matting has been laid so that the cold tails from each mat can be connected directly into the thermostat without the need to extend the cold tail.

Fig. 17



## Cable Mat Installation Continued.....

### Step 5

Test the resistance of the cable mat prior to installing and ensure that the reading is as per manufactures design reading. This can be found on the adhesive label on the mat or printed on the PVC sheath ( $\pm 10\%$ ). Make a note of the reading. Test the insulation of the cable by checking that there is no electrical continuity between each of the conductors and the earth braid. If you find there is continuity contact your underfloor heating supplier or the floor heating helpline printed on the back of these instructions.

**Do not tile over the cable without testing it.**

### Step 6

Only when you have planned the mat layout and are sure the mat will fit into the room, should you begin to lay. Beginning at the corner closest to where you have located the thermostat, position the mat ready to start rolling out.

**Important:** Before rolling out, check that the black cold lead will reach the location of the thermostat. If it does not, you should either change the starting point, or remove some of the cable from the starting end of the mat and run this along the edge of the room to allow the cold cable to reach the thermostat. Important Note: The joint between the black 'cold' cable and heater cable must be located under the final floor covering. This loose cable can be fixed down with a self adhesive cloth tape.

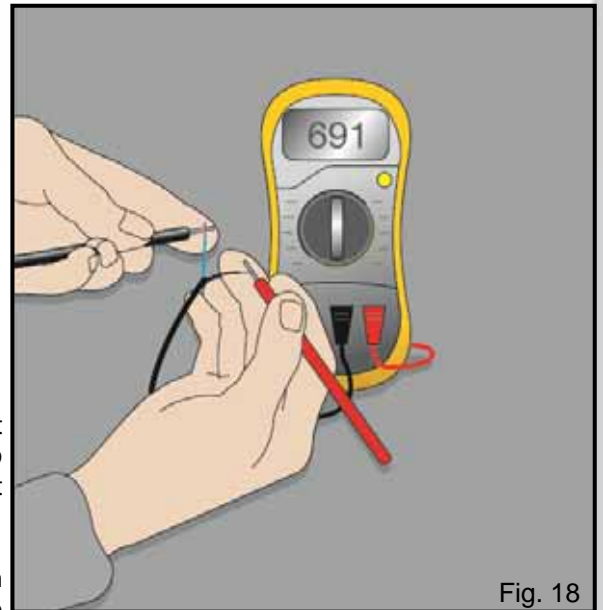

Fig. 18

### Step 7

From the start point roll out the mat. The mat is self-adhesive and can be laid either way up. When you reach the opposite corner of the room cut through the mesh. **DO NOT CUT THE CABLE.** Turn the mat through 180 degrees and roll back the other way, making sure that there is at least 50mm clearance between each cable loop. Continue this process until the entire mat is used up. If you are using two or more mats, try to finish off at the opposite wall so that the second mat is easier to lay, see example 5, Page 10:

Once all the matting is laid out, you can make slight adjustments to the positioning of the mat runs. When you are satisfied with the layout, firmly press down the matting with the palm of your hand to ensure the mat is fixed to the floor.

Any irregular shaped areas or a section of floor that will not accommodate a full width on matting, can be heated by removing the cable from the mesh matting. It can then be laid loose on the floor and fixed in place with self adhesive cloth tape (duct tape). When running the cable loose from the matting the cable should be spaced similarly to when it is attached to the mat. Cables should be spaced no closer than 50mm.

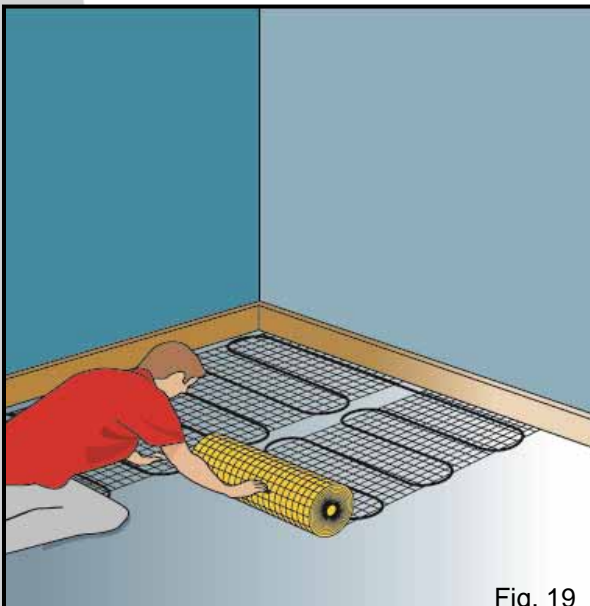

Fig. 19

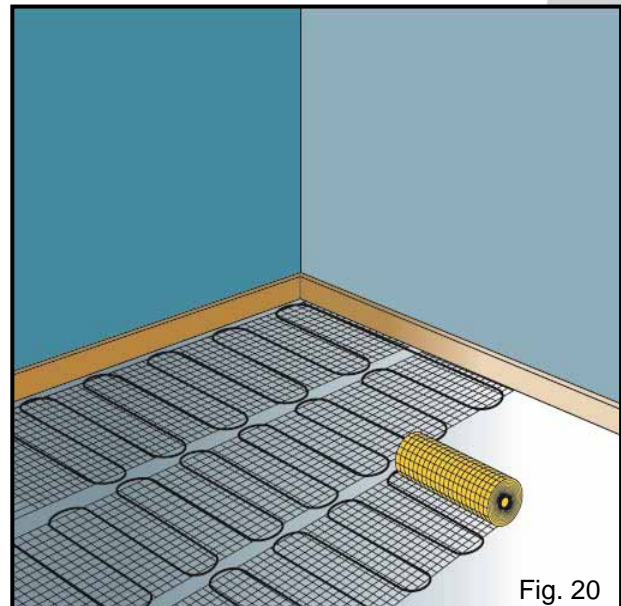

Fig. 20



### Cable Mat Installation Continued.....

#### Step 8

Test the resistance of the floor probe. Refer to the label on the floor probe wrapper for desired resistance readings. Make a note of the reading on the guarantee certificate.

The floor sensor should be installed within a flexible conduit. Fig 21. The conduit should be positioned so that the tip of the sensor is between two runs of cable on the mat, in a location that will not be covered by rugs or low profile furniture.

The sensor wire should not cross the heating cable at any point. The sensor wire can be shortened or if necessary, lengthened with 2 core flex cable minimum 0.75mm<sup>2</sup> to a maximum length of 50m. If you need to cut the sensor wire you must only cut the cable end. DO NOT cut the end which contains the plastic coated floor sensor.

Fig. 21

Installation of the conduit should be done carefully to make the bends as smooth and shallow as possible.

In some situations a small channel may have to be made in the floor to accommodate the tubing. If so, cut a channel from the thermostat position approximately 20cm across the floor. It is important that the channel is positioned so that it lays between two heating wires and not across them.

The end of the conduit that is in the floor should be sealed with tape to prevent adhesive entering the tube.

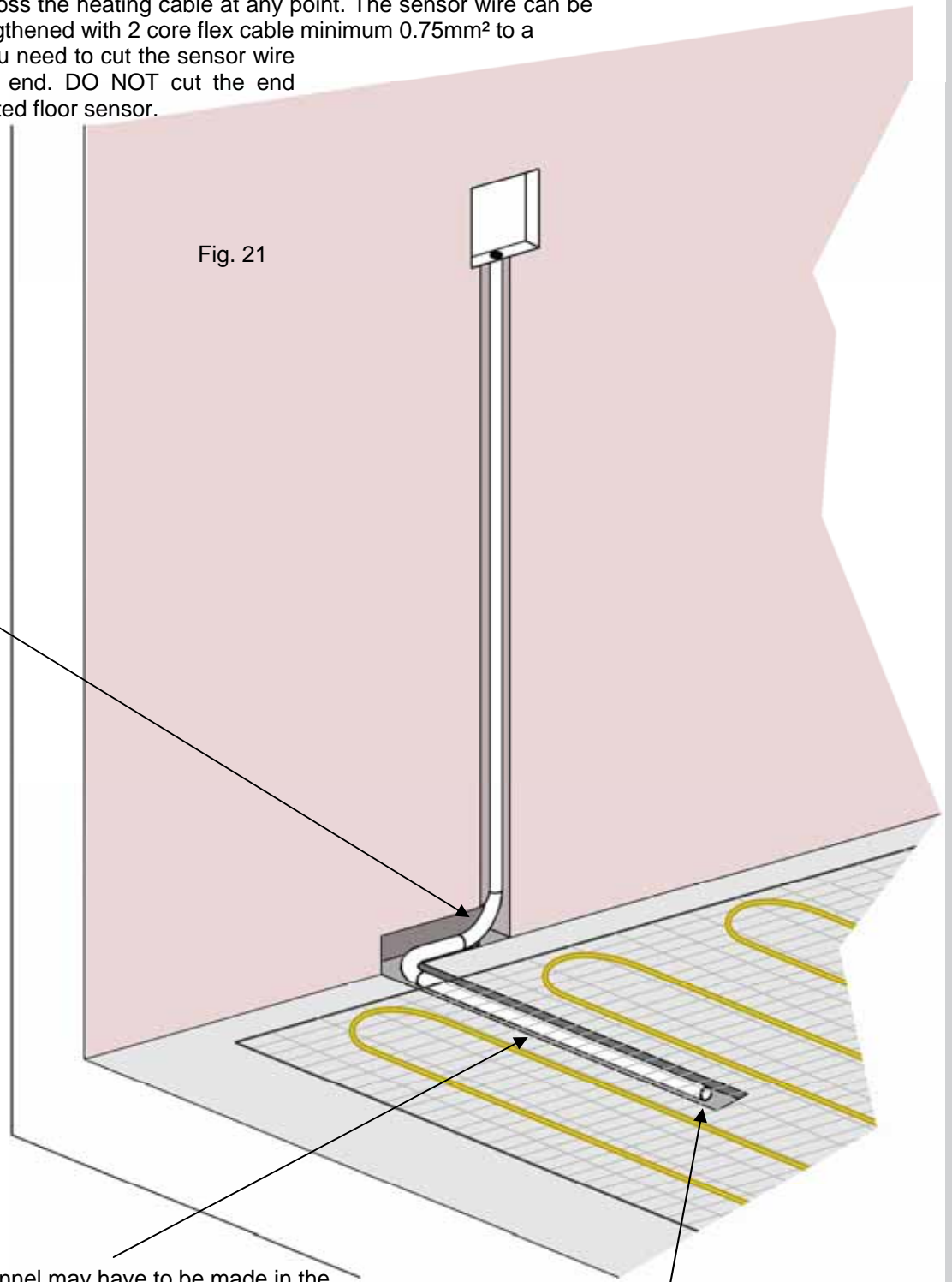



### Step 9

Test the cable mat resistance and the cable insulation along with the floor probe immediately prior to tiling to ensure that neither has been damaged. Compare readings with those recorded earlier.

*Note: This test can be performed at any stage of tiling for peace of mind. A cable break monitor device can also be used to alert you if the cable has been damaged. Such devices are available from your underfloor heating supplier.*

UNDER NO CIRCUMSTANCES should power be supplied to the cable mat when it is still rolled or partly rolled up.

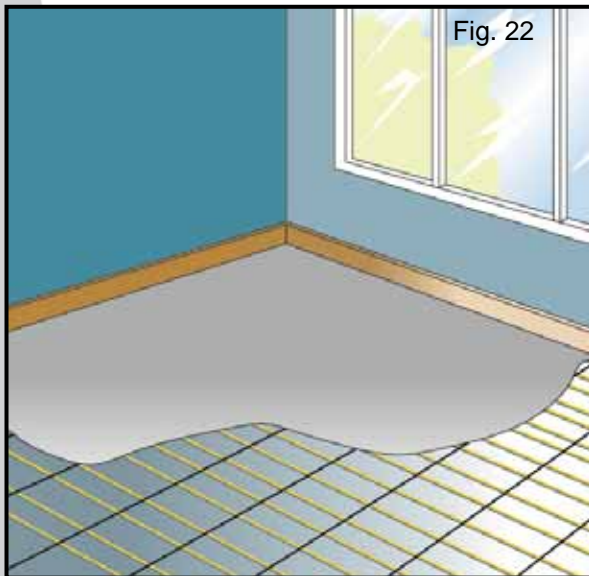

### Step 10

If possible cover the mat with a levelling screed (3-4mm)

Fig 22. This will help protect the mat when tiling. If you do not wish to use a levelling screed, you may tile directly over the mat in a single operation. Tile the floor using a flexible tile adhesive and grout as per industry standards and the manufacturer's instructions. Wait at least ONE WEEK before turning the heating system on to allow time to dry. If you are using a suitable vinyl or thin carpet as the final flooring, you will need to cover the mat with a suitable levelling screed - we recommend a minimum of a 6mm covering over the mat to ensure even heat distribution.

### Step 11

After the floor covering has been laid, test the Cable and Floor Probe one last time to ensure that neither have been damaged. Record final readings and complete the Guarantee Certificate as per the instructions on the certificate. If this is not done the Guarantee is invalid. Retain the certificate for your records.

### Step 12

The connections to the thermostat can now be made. (see separate thermostat instructions). Final connections to the thermostat must be performed by a competent person. Refer to Electrical Industry standards regulations and Building Regulation Part 'P' .

**DO NOT turn the system on until the floor covering has been laid and allowed time to set.**

*NOTE: The heating may be slow to react at first especially if installed on a new screed floor or in a new building. Start by setting the floor temperature at around 20-22°C and build up by 1°C per day until your desired temperature is reached. Please see separate instructions for connection and operation of the digital thermostat.*

### DO'S and DON'TS

- |       |   |  |
|-------|---|--|
| DO    | – | Read through these instructions carefully before beginning work  |
| DO    | – | Use flexible adhesives and grouts  |
| DO    | – | Test the cable mat and floor probe BEFORE tiling See steps 5, 8, 9 and 11                              |
| DO    | – | Be careful not to damage or dislodge the cable during tiling   |
| DO    | – | Try to protect the cable mat with cardboard or carpet during tiling                                    |
| DO    | – | Wait at least 7 days before turning on the system  |
| DO    | – | Read the separate installation and operating instructions for the thermostat                           |
| DO    | – | Ensure that the joint between the 'Cold' Cable and 'Heater' Cable is beneath the final floor covering. |
| DON'T | – | Attempt to cut the heater cable at any point   |
| DON'T | – | Allow the wires to cross or touch  |
| DON'T | – | Allow excessive foot traffic over the wire before tiling   |
| DON'T | – | Cut tiles directly over the cable  |
| DON'T | – | Place tools or stacks of tiles on top of the cable   |



## Trouble shooting & FAQ's

- Q. Does it matter which way around the heating cables are connected to the load terminals of the thermostat?**  
 A. No, There is effectively no live or neutral polarity to the heating element, therefore they can be connected either way around.
- Q. What are the silver stranded wires in the cold tail for?**  
 A. This is the earth braid. The strands need to be twisted together and connected to earth.
- Q. When I perform the resistance test on the heating element I cannot get a reading or the reading shows out of range?**  
 A. Check that the test equipment you are using is on the correct setting and that the tester probes are in contact with the conductors of the heating element. Some professional electrical testing equipment is designed to test low resistance electrical circuits. Electric heating elements have a high resistance, some of the small heating cables with a resistance above 200Ω may show as out of range on such equipment. A low cost electronic multi-meter is often the best device to use to check the resistance of the heating cable.
- Q. What should be used to house the thermostat?**  
 A. Recommended depth 35mm, single gang socket box. Can be either surface or flush mounted.
- Q. The heating element(s) is too large for the room, can they be cut?**  
 A. Under no circumstances should the heating element be cut. If you find you have too much heating element, attempt to lose the excess cable in an adjacent area or use the clearance left at the edge of the room, maintaining a minimum of 50mm clearance between cables. Failing this contact the floor heating helpline.
- Q. Can the elements be overlapped?**  
 A. Under no circumstances should the heating cable/cable mat be overlapped or crossed.
- Q. Can the heating system be installed onto a bitumen covered floor?**  
 A. If there is only a thin residue of bitumen on the existing sub-floor, usually where the bitumen had previously been used to fix vinyl tiles or similar, then you may lay the heating system down. If the bitumen covering has been used as a damp-proof membrane and is several millimetres thick, then this layer must be covered, either with a tile backer board or a levelling compound/screed, before the heating system can be laid.
- Q. What type of levelling compound "latex" should be used?**  
 A. Most floor levelling compounds that are available from tile suppliers will usually state on the packaging as to whether they are suitable for underfloor heating and are commonly referred to in the trade as "Latex". The term latex refers to screed products that are modified to be laid very thinly, only a few mm thick. They are available in 2-part and 1-part mixes. A 2-part mix consists of a bag of compound and a container of flexible additive. 1-part mixes have a bag of compound that simply has water added to it. We generally recommend the 2-part type, as they tend to be easier to achieve the correct mix, than the 1-part type. If you are in any doubt ask the supplier/manufacturer.
- Q. What type of adhesive and grout should be used?**  
 A. Any flexible tile adhesive and grout should be suitable. Most products will usually state on the packaging as to whether they are suitable for underfloor heating. If you are in any doubt ask the supplier/manufacturer. We do not recommend using ready mixed tile adhesive.

These instructions are correct at time of writing  
 For help and advice regarding this product, please contact the  
**Floor Heating Helpline: 0115 963 2342**